

Monochromatic Path Covers in Nearly Complete Graphs *

A. Gyárfás† A. Jagota‡ R.H. Schelp‡

† Computer and Automation Institute, Hungarian Academy of Sciences
Budapest, Hungary

‡ Department of Mathematical Sciences, University of Memphis
Memphis, TN, 38152

Abstract

It is known that in every 2-coloring of the edges of the complete graph there exist two vertex disjoint paths—one red, one blue—that collectively cover all the vertices. In this paper, analogous existence and efficiency questions are examined when edges are missing from the complete graph. The main result shows the existence of a path cover when at most any $\lfloor n/2 \rfloor$ edges are missing. An example shows this result is sharp. A second result shows that a path cover can be found efficiently if a matching is missing.

The following graph-theoretic notation is used in this paper. A path on k vertices is denoted by P_k . A subgraph of G induced by a vertex-set S is denoted by $G[S]$. An edge between x and y is denoted by xy . The minimum degree in a graph G is denoted by $\delta(G)$. A k -star is a graph containing exactly k edges, all incident to one vertex.

The following notation is used in connection with the specialized topic of this paper. A graph is *2-colored* if each edge is colored either red or blue. A *red path* (blue path) in a 2-colored graph is a simple path all of whose edges are red (blue). A one-vertex path may be labeled red or blue. A *red-blue path-cover* in a 2-colored graph consists of two vertex disjoint paths—one red and one blue—whose union covers all the vertices. A *bipath* in a 2-colored graph is a simple path comprised of a red subpath followed by a blue subpath. A *switchpoint* in a bipath is a vertex that connects the

*The research of A. Gyárfás is partially supported by grants OTRA 7309 and OTKA 16414.

The research of R.H. Schelp is partially supported under NSF grant number DMS-9400530.

two differently-colored subpaths. An *edge-test* is a test for the presence of an edge and, if present, its color.

We begin by considering the result for complete graphs.

Theorem 1 [3] *Every 2-colored K_n has a red-blue path-cover, and one can be found with $O(n)$ edge-tests.*

The essence of the simple proof is included, since it will be useful to the reader.

Proof : The following algorithm sequentially extends a pair of red and blue paths until all vertices are covered. At some point, the pair of paths is as shown in Figure 1a.

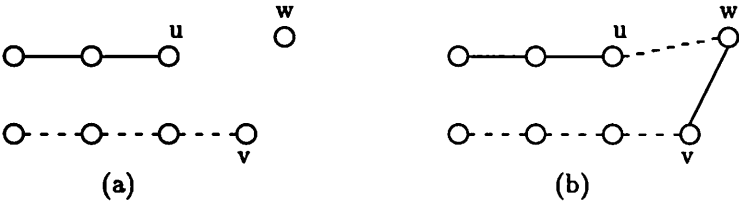

Figure 1: Illustration of Thm 1 proof. Solid line denotes red; dashed line blue.

Consider a vertex w not on the paths. If wu is red or wv blue, add w to the end of the appropriate path. If not, one obtains the situation in Figure 1b. If uv is red, delete v from the blue path, and add v followed by w to the red path. The case when uv is blue is symmetric. ■

This paper addresses the following questions.

1. How many edges can be deleted from K_n while guaranteeing the existence of a red-blue path-cover? Surprisingly, one can give a precise answer: $\lfloor n/2 \rfloor$ (Theorem 4). The proof relies on a result stated in [3] which is a corollary of the proof method used in [5] to find the path-path Ramsey number of complete bipartite graphs. It is worth mentioning that Theorem 1 has an infinite analogue for arbitrary numbers of colors [8]. On the other hand, for 3-colored complete graphs there is no red-blue-yellow path cover, shown by an example of K. Heinrich [6]. For related path-covering problems and other variants, see [2, 4].
2. Under what conditions on the deleted edges can a red-blue path-cover be efficiently found? Our interest is in measuring the efficiency in terms of the number of edge-tests involved in finding a red-blue path-cover, a notion closely-related to that of “decision-tree complexity”

of graph properties [7, p. 5] and of elusiveness of graph properties [1, p. 402]. Theorem 2 together with Corollary 3 generalizes Theorem 1. The authors are unable to presently answer the following question: what is the largest k in the range $0 \leq k \leq n/2$ for which the required path cover can be found with $O(n)$ edge-tests in a graph obtained by deleting k edges from K_n .

The second question is addressed first.

Theorem 2 For $n \geq 5$, every 2-colored $K_n \setminus M$, where M is any matching, contains a red-blue path-cover.

First, a simple example shows that Theorem 2 is not true for $n = 4$.

Proof : The proof is by induction on n .

Basis: $n = 5$. The claim is that in any 2-coloring of $K_5 \setminus M$, there is a monochromatic P_4 . Select a vertex v whose degree is 4.

Case 1: The degree of v in one color, say red, is at least 3. The situation is depicted in Figure 2a. The set W must contain at least two edges and both must be blue, otherwise there is a P_4 in red. The fifth vertex x must be adjacent to at least two vertices in W and both must be blue, otherwise again there is a P_4 in red. But now, as shown in Figure 2b, there is a P_4 in blue.

Case 2: The degrees of v in both colors are 2. The situation is depicted in Figure 2c. Consider any edge e joining vertices from W and X . If e is red there is a P_4 in red; if e is blue there is a P_4 in blue.

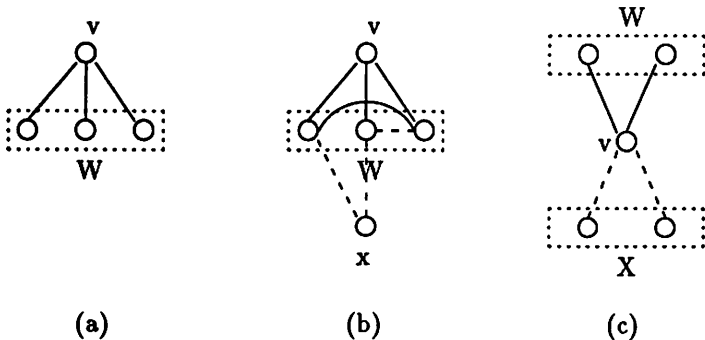

Figure 2: Illustration of Thm 2 proof: Basis of induction. Solid line denotes red; dashed line blue.

Inductive step. Define $|P|$ as the number of vertices in path P .

Case 1: $|P_r| \geq 2, |P_b| \geq 2$. Let s be a vertex not in P_r or P_b . Vertex s is adjacent to three or more of u, v, w, x , say w, x, v . The edges from s to w, x, v must be colored as shown in Figure 3a, otherwise s extends P_r or P_b from some endpoint. Vertex v must be adjacent to w or x , say x . The situation is now the same as in Figure 1b.

Case 2: $|P_b| = 1$. If s is not adjacent to w , as shown in Figure 3b, v must be adjacent to s as well as to w . If vs or vw is red, s or w extends P_r from endpoint v . Otherwise, both are blue, and one deletes v from P_r and $P_b := (s, v, w)$. If s is adjacent to w then, as shown in Figure 3c, sw must be red, otherwise s extends P_b . Of the four edge-slots, $(s, a), (v, w), (s, v), (a, w)$, at least two matched ones contain edges. Using symmetry, let them be sv and aw , as shown in Figure 3d. Both aw and sv must be blue, otherwise the proof is complete. Now both sa and vw must be missing, otherwise the proof is again complete. The situation at this point is depicted in Figure 3e. Now uw and us must be edges, and independent of their colors the red-blue path-cover is extended. The case when both edges are blue is shown in Figure 3f.

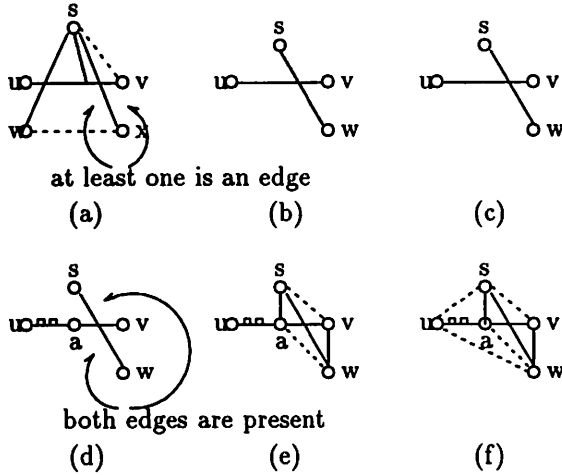

Figure 3: Illustration of Thm 2 proof: inductive step. Dotted line denotes missing edge; solid line red; dashed line blue. Vertex 'a' is adjacent to vertex 'v' on P_r .

■

Corollary 3 For $n \geq 5$, in every 2-colored $K_n \setminus M$, a red-blue path-cover can be found with $O(n)$ edge-tests.

Proof : In each inductive step, a constant number of edge-tests are performed. ■

How many edges can be deleted from K_n while guaranteeing the existence of a red-blue path-cover in any 2-coloring? The answer, given by the example in Figure 4, is that not more than $\lfloor n/2 \rfloor$.

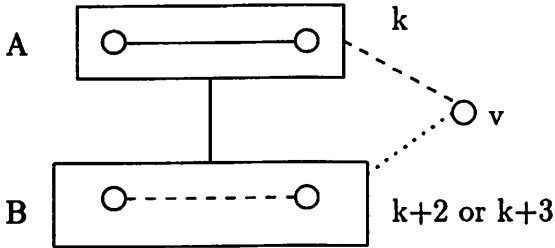

Figure 4: Extremal example. A and B are complete red and complete blue subgraphs respectively. A contains k vertices. B contains $k + 2$ vertices when n is odd and $k + 3$ vertices when n is even. A and B are joined in red. v misses all edges from B. v is joined to A in blue.

Packing Lemma. Let G_n denote a graph obtained by deleting at most $\lfloor n/2 \rfloor$ edges from K_n . For $n \geq 7$, if \bar{G}_n , the complement of G_n , is not a $\lfloor n/2 \rfloor$ -star, then $V(G_n)$ can be partitioned into two classes A and B, $|A| \geq |B|$, $|A| - |B| \leq 2$, with the deleted edges packed within the classes, in such a way that both $G[A]$ and $G[B]$ are connected graphs.

Proof : By induction on n .

Basis: $n=7$. At most 3 edges are missing. Figure 5 shows the ways in which 3 edges can be missing (except the 3-star case) and, with each way, gives the corresponding (A, B) partitions.

Inductive step.

Case 1: n is odd. By counting missing edges, the situation in Figure 6a results. By the assumption, the remaining graph on $n - 1$ vertices has an appropriate partition (A, B) . One then adds v to the smaller of A or B (or arbitrarily if both have equal-size).

Case 2: n is even.

If, as shown in Figure 6b, there is a vertex v which misses exactly one edge, then v can be selected so that its removal does not leave a $\lfloor (n - 1)/2 \rfloor$ -star in the missing edges. Then, by the assumption, the remaining graph

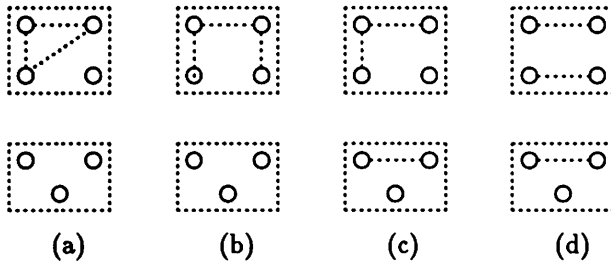

Figure 5: Illustration of Packing Lemma proof: Basis of induction.

on $n - 1$ vertices has an appropriate partition (A, B) with $|A| - |B| \leq 1$. One then adds v to the class to which it misses an edge.

If not, then every vertex misses either 0 edges or ≥ 2 edges. Then, as shown in Figure 6c, let B denote the set of vertices missing 0 edges. By counting missing edges, $|A| \leq n/2$, so that some vertices can be moved from B to A , if necessary, to make the classes meet the “almost balanced” constraint.

To check that both $G[A]$ and $G[B]$ are connected graphs, one reexamines each of the cases in Figures 6a-c. The Figure 6a case is trivial because v misses no edges. To handle the Figure 6b case, note that $|A| \geq 2$ and $|B| \geq 2$. The results follows because v misses exactly one edge. To handle the Figure 6c case, note that $|A| \leq |B|$ and A and B are joined completely joined by edges. One can move a vertex from B to A . Now both $G[A]$ and $G[B]$ are connected graphs.

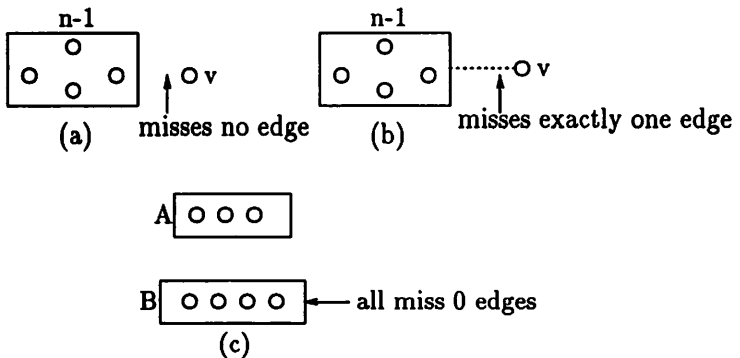

Figure 6: Illustration of Packing Lemma proof: inductive step.

■

Theorem 4 For $n \geq 5$, every 2-coloring of a K_n with at most any $\lfloor n/2 \rfloor$ edges deleted contains a red-blue path-cover.

Proof : The constructive proof is presented top-down.

1. Using the Packing Lemma, one partitions V into equally or almost balanced parts A and B so that there are no missing edges between A and B (see Figure 7a).
2. One removes, if necessary, certain vertices from the larger part to exactly balance the rest (see Figure 7b).
3. One applies the following result from [3]: A 2-colored $K_{m,m}$ has either an exceptional coloring (see Figure 8b) or contains a bipath P which covers all but one vertex of $K_{m,m}$ and both the red and blue subpaths of P (one may be empty) contain an even number of vertices (see Figure 8a).
4. One handles the two cases of Figure 8 separately. For each case, a red-blue path-cover is constructed when the classes are equally-balanced, and this cover is modified to include removed vertices when they are not equally-balanced (see Figure 7b).

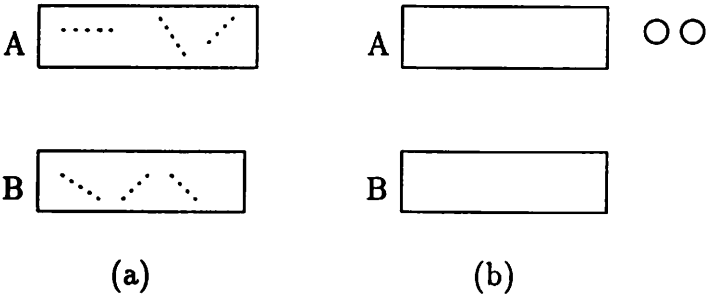

Figure 7: Illustration of steps 1-2 of Thm 4 proof.

One now refines these steps, but before doing that, one notes two exceptional cases when the Packing Lemma does not hold: (i) $n < 7$ and (ii) when \bar{G}_n is a $\lfloor n/2 \rfloor$ -star. These cases are treated separately at the very end.

Step 1. Nothing more needs to be said.

Step 2. If n is odd, a vertex p_1 is removed from the larger class with missing degree at most 1. If n is even and $|A| - |B| = 2$, vertices p_1 and

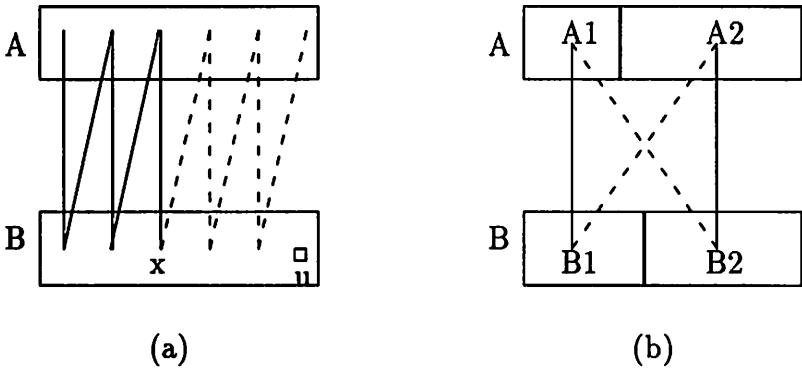

Figure 8: Illustration of step 3 of Thm 4 proof. (b): Lines connecting classes indicate all edges have the color denoted by the line. Any of the sets A_1, A_2, B_1, B_2 may be empty.

p_2 are removed from the larger class C , $C = A$ or B , each with missing degree at most 1 in $C \setminus \{p_1, p_2\}$. If n is even and $|A| = |B|$, nothing is done. Removed vertices satisfying these constraints always exist, by the Packing Lemma.

Step 3. Nothing more needs to be said.

Step 4. The shown cases in Figure 8 are handled as follows. First, for n even with $|A| = |B|$, a red-blue path-cover is found. Next, if n is odd, a red-blue path-cover that includes p_1 is found. If n is even and $|A| - |B| = 2$, the odd n case is modified to give a path-cover to include p_2 .

Case 1: The balanced partition has the structure of Figure 8a.

Case 1.1: Even $n \geq 8$, $|A| = |B|$. First, the situation must be as shown in Figure 9a, otherwise the desired cover is obtained. Likewise, to avoid the desired cover, vx is blue and wx is red (see Figure 9a) giving the coloring shown in Figure 9b. By the Packing Lemma, there is an edge e as shown in Figure 9b. Clearly, independent of the color of the edge e , the desired cover is obtained.

Case 1.2: Odd $n \geq 7$. It will be seen that there are only two types of red-blue path-covers that can occur, those shown in Figure 10.

By symmetry, without loss of generality, xp_1 is red (see Figure 11a).

$$\left. \begin{array}{l} \text{If } p_1u \text{ is red, or} \\ \text{one of } ua_1 \text{ and } ua_2 \text{ is blue} \end{array} \right\} \implies \text{a type-1 red-blue path-cover forms.}$$

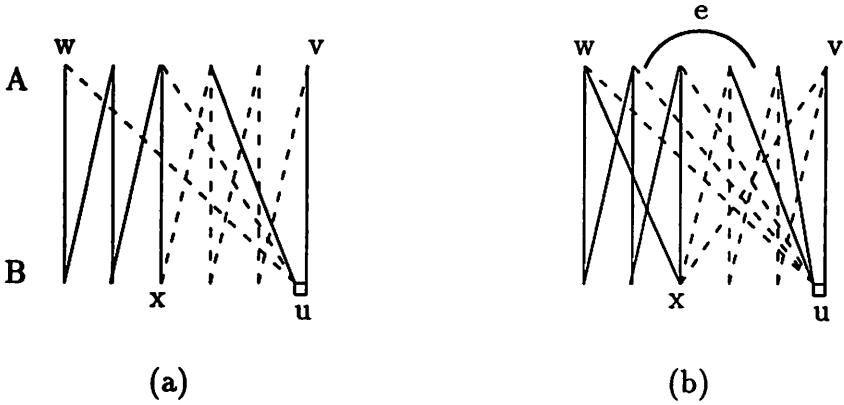

Figure 9: Case 1.1: Even n , $|A| = |B|$.

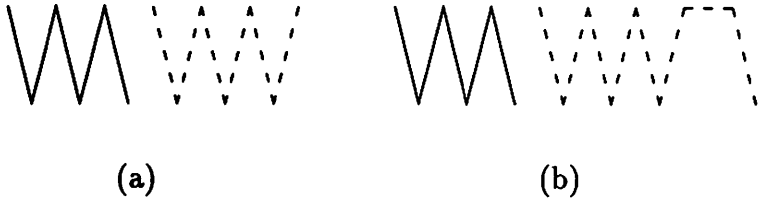

Figure 10: Case 1.2: Odd n . (a) type-1, (b) type-2

Otherwise the situation is as diagrammed in Figure 11b. Now p_1a_i , $i = 1$ or 2 , in any color gives a type-1 or type-2 red-blue path-cover, and one of p_1a_1 or p_1a_2 is not missing, from the choice of p_1 .

Case 1.3: Even $n \geq 8$, $|A| - |B| = 2$. The following observation is used: if there is a bipath in a graph G with switchpoint s , and t is a vertex not on the bipath with t adjacent to s , then there exists a pair of disjoint red and blue paths in $G \cup t$, no matter which color is assigned to st . This is referred to as taking the *bipath extension with switchpoint s* .

Extension for type-1. See Figure 12a. If mn_1 or mn_2 is blue, then one takes the bipath extension with switchpoint m . If both mn_i are red, then one takes the bipath extension with switchpoint n_1 or n_2 — p_2n_1 or p_2n_2 is an edge from the choice of p_2 .

Extension for type-2. See Figure 12b. If m_1n_1 is blue, then one takes the bipath extension with switchpoint m_1 . If m_2n_2 is red, then one takes the bipath extension with switchpoint m_2 . Otherwise, one takes the bipath

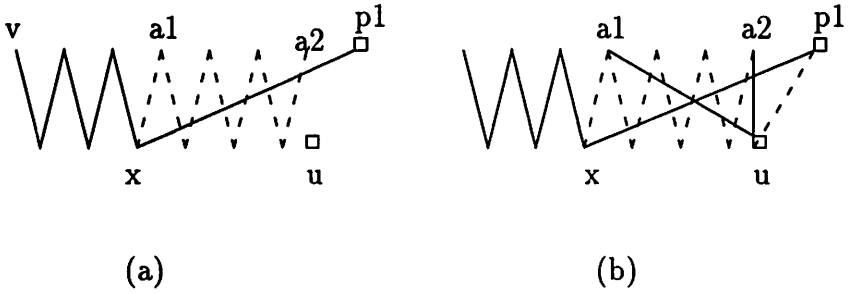

Figure 11: Case 1.2: Odd n .

extension with switchpoint n_1 or n_2 , since p_2 is adjacent to at least one of them.

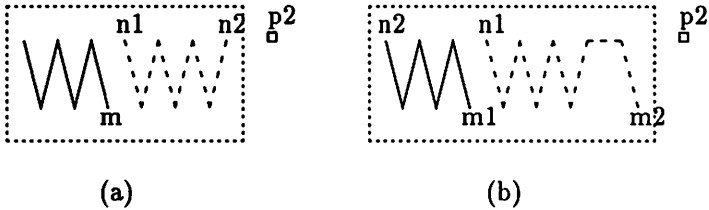

Figure 12: Case 1.3: Even n , $|A| - |B| = 2$.

Case 2: The balanced partition has the structure of Figure 8b.

Case 2.1: Even $n \geq 8$, $|A| = |B|$. This will be handled as a special case of Case 2.2. It may be checked that the argument in Case 2.1 goes through when the vertex p_1 is absent, i.e. when $|A| = |B|$.

Case 2.2: Odd $n \geq 7$. The following simple idea is used repeatedly: if two vertex-disjoint vertex sets X and Y , $|X| \geq |Y|$, $|X| - |Y| \leq 1$, are completely joined in one color, one can construct a monochromatic path covering $X \cup Y$ by starting from any vertex in X and visiting any uncovered vertices in Y and X alternately. Such a path is denoted by $X \bowtie Y$.

Without loss of generality, one may assume the situation is as diagrammed in Figure 13. Notice that, while in previous figures $|A| \geq |B|$, this is no longer true. The existence of a vertex y in A_2 adjacent to p_1 is argued as follows. If p_1 is in B , then by the Packing Lemma, p_1 is joined to A_2 . Otherwise, by the Packing Lemma, one may choose p_1 so that it misses at

most one edge from A_2 . Since A_2 is the largest class among A_1, B_1, B_2, A_2 and $n \geq 7$, $|A_2| \geq 2$.

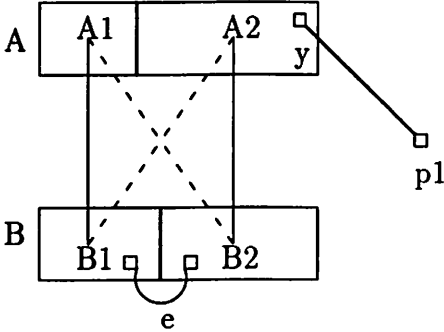

Figure 13: Case 2.2: Odd n . $|A_1| \leq |B_1| \leq |B_2| \leq |A_2|$ where A_1, B_1 or both may be empty. e denotes an edge joining a vertex in B_1 with one in B_2 , if B_1 is not empty. Its existence is given by the Packing Lemma. Wide solid line indicates an edge with color unspecified.

Suppose A_1 is empty. If B_1 is also empty, taking p_1 as the blue path and $A_2 \bowtie B_2$ as the red path forms a red-blue path-cover. If B_1 is not empty, y can be assumed to be in A_{22} , as shown in Figure 14a, since A_{21} and A_{22} are interchangeable. There is clearly a red-blue path-cover, whether edge p_1y is red or blue.

Suppose A_1 is not empty.

Case 2.2.1: Edge e is colored red. Vertex y can be assumed to be an element of A_{22} because the partition of A_2 into A_{21} and A_{22} is arbitrary. Thus the situation of Figure 14b holds.

If B_{12} and A_{21} are empty, taking p_1 as the blue path and $(A_{22} \bowtie B_2, e, B_{11} \bowtie A_1)$ as the red path gives a red-blue path-cover. Otherwise, if p_1y is red, one can take $B_{12} \bowtie A_{21}$ as the blue path and $(p_1y, A_{22} \bowtie B_2, e, B_{11} \bowtie A_1)$ as the red path. If p_1y is blue, one can take $(p_1y, y, B_{12} \bowtie A_{21})$ as the blue path and $(zw, B_2 \bowtie A_{22} \setminus y, e, B_{11} \bowtie A_1)$ as the red path, as shown in Figure 14c.

Case 2.2.2: Edge e is colored blue. Vertex y can be assumed to be an element of A_{23} because the partition of A_2 into A_{21}, A_{22} , and A_{23} is arbitrary. Thus the situation of Figure 15a holds.

Notice that both A_{21} and A_{23} are non-empty. If A_{22} and B_{21} are empty, taking p_1 as the red path and $(A_{23} \bowtie B_{12}, e_1, A_{21} \bowtie B_{11}, e, B_{22} \bowtie A_1)$ as the

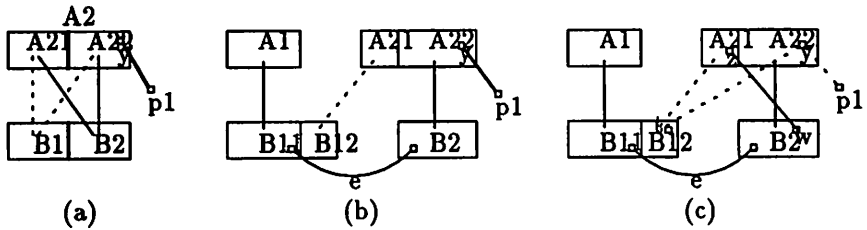

Figure 14: Cases 2.2, 2.2.1. (a) $|A_{21}| = |B_1|, |A_{22}| = |B_2|$. p_1 is adjacent to some vertex y in A_{22} . (b) $|B_{11}| = |A_1|, |A_{22}| = |B_2|$, hence $|B_{12}| = |A_{21}|$.

blue path gives a red-blue path-cover. Otherwise, if p_1y is blue, one can take $(p_1y, A_{23} \bowtie B_{12}, e_1, A_{21} \bowtie B_{11}, e, B_{22} \bowtie A_1)$ as the blue path and $A_{22} \bowtie B_{21}$ as the red path while, if p_1y is red, one can take $(p_1y, e_2, B_{21} \bowtie A_{22} \setminus z)$ as the red path and $((A_{23} \cup z) \setminus y) \bowtie B_{12}, e_1, A_{21} \bowtie B_{11}, e, B_{22} \bowtie A_1)$ as the blue path, as shown in Figure 15b.

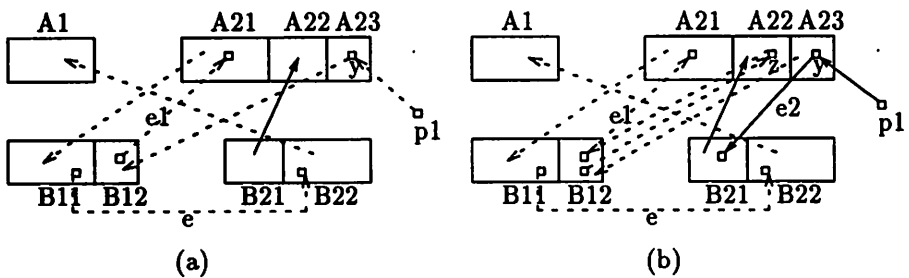

Figure 15: Case 2.2.2. (a) $|A_1| = |B_{11}| = |B_{22}| = |A_{21}|, |B_{12}| = |A_{23}|, |A_{22}| = |B_{21}|$.

Case 2.3: Even $n \geq 8, |A| - |B| = 2$. The proof follows quite easily from the odd case (Case 2.2) by extending the red-blue path-covers to include p_2 , as done in Case 1.3. Reexamining the covers obtained in Case 2.2 shows that they can be classified into the two types shown in Figure 16. In both cases, the vertex p_2 is attached to the larger class. Depending on the colors of the vertex t to the endpoints of the red path, one gets the four possibilities shown in Figure 17. The covers in Figure 17a and Figure 17b are extended to include p_2 by taking the bipath extension with switchpoint t (see Case 1.3). The situations in Figure 17c and Figure 17d are handled as follows. Since, by choice, p_2 misses at most one vertex in the larger class, p_2 is adjacent to z or w in both situations. It is easily checked that,

regardless of the color of the edge connecting p_2 with z or w , a red-blue path-cover always exists.

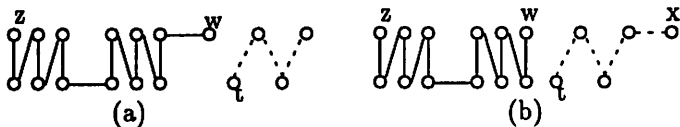

Figure 16: Case 2.3: Two types of red-blue path-covers in Case 2.2.

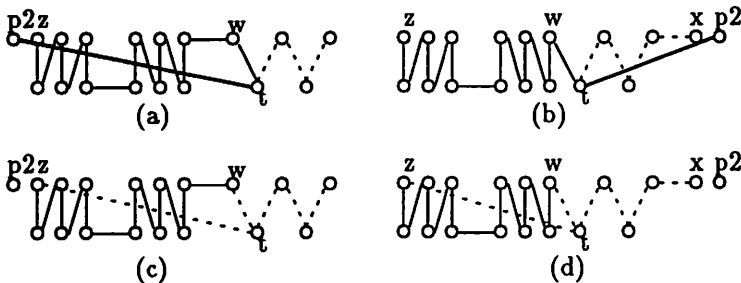

Figure 17: Case 2.3: Four possibilities, depending on the colors of tz and tw

Case 3: Exceptional cases for the Packing Lemma. For exceptional situations involving Case 1, a weaker version of the Packing Lemma called Packing Lemma B is used. In Packing Lemma B it is no longer assumed that $G[A]$ and $G[B]$ are connected graphs. Packing Lemma B holds for $n \geq 1$ and also when \bar{G}_n is a $\lfloor n/2 \rfloor$ -star, as may be seen by examining the proof of the Packing Lemma. (The Basis goes through with $n = 1$.)

Case 3.1: \bar{G}_n is a $\lfloor n/2 \rfloor$ -star. Let X denote the set of $\lfloor n/2 \rfloor$ vertices that induces the $\lfloor n/2 \rfloor$ -star in \bar{G}_n .

Case 3.1.1: Odd $n \geq 5$. Pick any vertex p_1 from X with missing degree exactly one. Set $A = X \setminus \{p_1\}$ and $B = V \setminus X$. By the result in [3], one of the situations depicted in Figure 8 holds, on (A, B) . If the situation depicted in Figure 8a holds, Case 1.2 goes through unchanged because it uses only Packing Lemma B (which holds for a $\lfloor n/2 \rfloor$ -star). If the situation in Figure 8a holds on (A, B) , then it will be shown that the situation depicted in Figure 13 or that in Figure 14a also holds. The appropriate part of the proof of Case 2.2 then goes through unchanged.

Consider, first, when $|A_1| \leq |B_1| \leq |B_2| \leq |A_2|$. Since $n \geq 5$, $|A_2| \geq 2$, implying the existence of the edge py_1 . If $B_1 = \emptyset$, one is done, else edge

e is present since $G[B]$ is a complete graph. Now consider that $|A_1| \leq |B_1| \leq |B_2| \leq |A_2|$ does not hold. Flip A and B . Let u denote the vertex in X with missing degree $\lfloor n/2 \rfloor$. Note that $B_1 \neq \emptyset$. If $B_1 \neq \{u\}$, edge e exists. Therefore assume that $B_1 = \{u\}$. Then $|A_1| \leq 1$. The choice of $|A_1| = 1$ contradicts our assumption about the relationship between the cardinalities of the various sets A_1, A_2, B_1, B_2 . Therefore $|A_1| = 0$, for which the situation depicted in Figure 14a, which does not need edge e , holds.

Case 3.1.2: Even $n \geq 6$. Pick vertices p_1 and p_2 , each with missing degree exactly one in $X \setminus \{p_1, p_2\}$. Set $A = X \setminus \{p_1, p_2\}$ and $B = V \setminus X$. Then $|A| = |B|$. If the situation in Figure 8a holds on (A, B) , then Case 1.2 followed by Case 1.3 goes through unchanged because each uses only Packing Lemma B. If, on the other hand, the situation in Figure 8b holds on (A, B) then, by case 3.1.1, the situation in Figure 13 or Figure 14a also holds, on $G_n \setminus p_2$. From this point on, Case 2.2 followed by Case 2.3 goes through unchanged.

Case 3.2: Low-order cases, $n = 5$ and $n = 6$. Assume that \bar{G}_n is not a $\lfloor n/2 \rfloor$ -star since this case is covered in Case 3.1.

$n=5$. Use Packing Lemma B, which holds for $n \geq 1$, to partition G into A and B , where $|A| > |B|$, with missing edges packed into A and B . Remove some vertex p_1 from A with missing degree at most 1. If the situation in Figure 8a holds, case 1.2 goes through unchanged because it does not need the additional power of Packing Lemma. If the situation in Figure 8b holds, it is handled as follows. If both A_1 and B_1 are empty, $G \setminus \{p_1\}$ contains a monochromatic P_4 ; $\langle p_1 \rangle$ is the path in the other color. If exactly one of A_1 and B_1 is empty, there exists an edge xp_1 , where x is a vertex in the class (A or B) containing the empty subclass. Such an edge exists since p_1 has missing degree at most one. Regardless of the color of xp_1 a path-cover can be easily constructed. At this point only the two situations shown in Figure 18 remain. In Figure 18a, w is adjacent to u and in Figure 18b one can assume that p_1 is adjacent in one of the colors to w and in the other to u . Then coloring edge p_1v in either color gives the desired path-cover.

$n=6$. Once again, use Packing Lemma B to partition G into A and B with the missing edges packed into A and B . If $|A| = |B|$, transform the partition into an unequal one (i.e., with $|A| - |B| = 2$) with the missing edges remaining packed in A and B . This can be done except when the missing edges form a perfect matching, which is a case already covered by Theorem 2. Remove two vertices p_1 and p_2 from A , each with missing degree at most 1 in $A \setminus \{p_1, p_2\}$. If the situation in Figure 8a holds, once again Case 1.2 followed by Case 1.3 goes through unchanged.

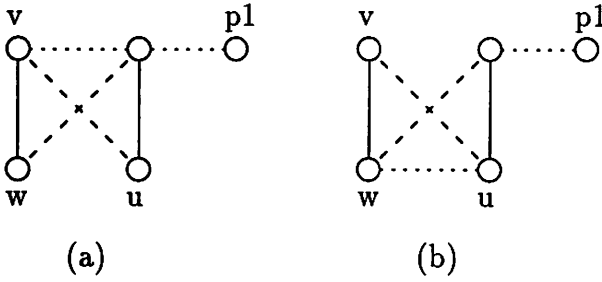

Figure 18: Case 3.2: $n = 5$.

If the situation in Figure 8b holds, handle it as follows. Here only a sketch of the argument is given. The case when $A_1 = B_1 = \emptyset$ is easy. Suppose when only $B_1 = \emptyset$. Using edges p_1x and p_2y , where $x, y \in B$, one may easily construct the desired path-cover. Suppose when only $A_1 = \emptyset$. Since \tilde{G}_6 is not a 3-star, one can always select p_1 and p_2 so that they are adjacent to different vertices in $A \setminus \{p_1, p_2\}$. Then the argument similar to that when only $B_1 = \emptyset$ can be used. Finally one considers when none of A_1, A_2, B_1, B_2 are empty. Let w and x be the two vertices in B and first consider when w is adjacent to x . One can always select p_1 and p_2 so that both are adjacent to the same vertex $y \in A \setminus \{p_1, p_2\}$. Using this fact this case may be easily finished. Next consider when w is not adjacent to x . Vertex p_1 is adjacent to w in one color and to x in the other, otherwise the result follows. This is also true for p_2 . Using the fact that $G[A \setminus \{p_1\}]$ contains at least one edge finishes this case. ■

Acknowledgments

The authors thank R. Faudree for helpful discussions. Packing Lemma B was discussed in conversation with P. Erdős; it was probably known earlier.

References

- [1] B. Bollobás. *Extremal Graph Theory*. Academic Press, New York, 1978.
- [2] P. Erdős, A. Gyárfás, and L. Pyber. Vertex coverings by monochromatic cycles and trees. *Journal of Combinatorial Theory Series B*, 51:90–95, 1991.

- [3] A. Gyárfás. Vertex coverings by monochromatic paths and cycles. *Journal of Graph Theory*, 7:131–135, 1983.
- [4] A. Gyárfás. Monochromatic path covers. *Proceedings of Twenty Sixth Southeastern International Conference on Combinatorics, Graph Theory, and Computing*, page to appear, 1995.
- [5] A. Gyárfás and J. Lehel. A Ramsey-type problem in directed and bipartite graphs. *Periodica Mathematica Hungarica*, 3(3–4):299–304, 1973.
- [6] K. Heinrich. Personal communication. 1995.
- [7] L. Lovász and N. Young. Lecture notes on evasiveness of graph properties. Technical Report CS-TR-317-91, Computer Science Department, Princeton University, Princeton, NJ 08544, USA, 1991.
- [8] R. Rado. Monochromatic paths in graphs. *Annals of Discrete Mathematics*, 3:191–194, 1978.